

PHASE CONTROL SCR

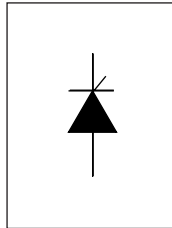

$V_T$	< 1.3V @ 20A
$I_{TSM}$	= 300A
$V_{RRM}$	800 to 1600V

**Description/Features**

The 30TPS.. **SAFEIR** series of silicon controlled rectifiers are specifically designed for medium power switching and phase control applications. The glass passivation technology used has reliable operation up to 125°C junction temperature.

Typical applications are in input rectification (soft start) and these products are designed to be used with International Rectifier input diodes, switches and output rectifiers which are available in identical package outlines.

**Major Ratings and Characteristics**

Characteristics	30TPS..	Units
$I_{T(AV)}$ Sinusoidal waveform	20	A
$I_{RMS}$	30	A
$V_{RRM}/V_{DRM}$	up to 1600	V
$I_{TSM}$	300	A
$V_T$ @ 20 A, $T_J = 25^\circ\text{C}$	1.3	V
dv/dt	500	V/ $\mu\text{s}$
di/dt	150	A/ $\mu\text{s}$
$T_J$	-40 to 125	$^\circ\text{C}$

**Package Outline**

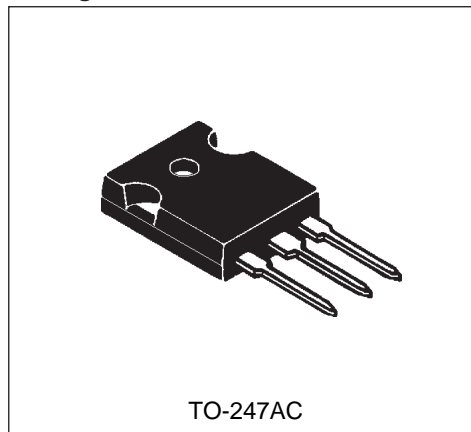

## Voltage Ratings

Part Number	$V_{RRM}/V_{DRM}$ , max. repetitive peak and off-state voltage V	$V_{RSM}$ , maximum non repetitive peak reverse voltage V	$I_{RRM}/I_{DRM}$ 125°C mA
30TPS08	800	900	10
30TPS12	1200	1300	
30TPS16	1600	1700	

## Absolute Maximum Ratings

Parameters	30TPS..	Units	Conditions
$I_{T(AV)}$ Max. Average On-state Current	20	A	@ $T_C = 95^\circ\text{C}$ , 180° conduction half sine wave
$I_{RMS}$ Max. RMS On-state Current	30		
$I_{TSM}$ Max. Peak One Cycle Non-Repetitive Surge Current	250 300		10ms Sine pulse, rated $V_{RRM}$ applied 10ms Sine pulse, no voltage reapplied
$I^2t$ Max. $I^2t$ for Fusing	310 442	$A^2s$	10ms Sine pulse, rated $V_{RRM}$ applied 10ms Sine pulse, no voltage reapplied
$I^2\sqrt{t}$ Max. $I^2\sqrt{t}$ for Fusing	4420		$A^2\sqrt{s}$
$V_{TM}$ Max. On-state Voltage Drop	1.3	V	@ 20A, $T_J = 25^\circ\text{C}$
$r_t$ On-state Slope Resistance	12	$m\Omega$	$T_J = 125^\circ\text{C}$
$V_{T(TO)}$ Threshold Voltage	1.0	V	
$I_{RM}/I_{DM}$ Max. Reverse and Direct Leakage Current	0.5 10	mA	$T_J = 25^\circ\text{C}$ $T_J = 125^\circ\text{C}$
			$V_R = \text{rated } V_{RRM}/V_{DRM}$
$I_H$ Max. Holding Current	100	mA	Anode Supply = 6V, Resistive load, Initial $I_T = 1A$
$I_L$ Max. Latching Current	200	mA	Anode Supply = 6V, Resistive load
dv/dt Max. Rate of Rise of off-state Voltage	500	V/ $\mu s$	
di/dt Max. Rate of Rise of turned-on Current	150	A/ $\mu s$	

### Triggering

Parameters	30TPS..	Units	Conditions
$P_{GM}$ Max. Peak Gate Power	8.0	W	
$P_{G(AV)}$ Max. Average Gate Power	2.0		
+ $I_{GM}$ Max. Peak Positive Gate Current	1.5	A	
- $V_{GM}$ Max. Peak Negative Gate Voltage	10	V	
$I_{GT}$ Max. Required DC Gate Current to Trigger	60	mA	Anode supply = 6V, resistive load, $T_J = -10^\circ\text{C}$
	45		Anode supply = 6V, resistive load, $T_J = 25^\circ\text{C}$
	20		Anode supply = 6V, resistive load, $T_J = 125^\circ\text{C}$
$V_{GT}$ Max. Required DC Gate Voltage to Trigger	2.5	V	Anode supply = 6V, resistive load, $T_J = -10^\circ\text{C}$
	2.0		Anode supply = 6V, resistive load, $T_J = 25^\circ\text{C}$
	1.0		Anode supply = 6V, resistive load, $T_J = 125^\circ\text{C}$
$V_{GD}$ Max. DC Gate Voltage not to Trigger	0.25		$T_J = 125^\circ\text{C}$ , $V_{DRM} = \text{rated value}$
$I_{GD}$ Max. DC Gate Current not to Trigger	2.0	mA	$T_J = 125^\circ\text{C}$ , $V_{DRM} = \text{rated value}$

### Switching

Parameters	30TPS..	Units	Conditions
$t_{gt}$ Typical Turn-on Time	0.9	$\mu\text{s}$	$T_J = 25^\circ\text{C}$
$t_{rr}$ Typical Reverse Recovery Time	4		$T_J = 125^\circ\text{C}$
$t_q$ Typical Turn-off Time	110		

### Thermal-Mechanical Specifications

Parameters	30TPS..	Units	Conditions
$T_J$ Max. Junction Temperature Range	- 40 to 125	$^\circ\text{C}$	
$T_{stg}$ Max. Storage Temperature Range	- 40 to 125		
$R_{thJC}$ Max. Thermal Resistance Junction to Case	0.8	$^\circ\text{C/W}$	DC operation
$R_{thJA}$ Max. Thermal Resistance Junction to Ambient	40		
$R_{thCS}$ Max. Thermal Resistance Case to Heatsink	0.2		Mounting surface, smooth and greased
wt Approximate Weight	6 (0.21)	g (oz.)	
T Mounting Torque	Min.	6 (5)	
	Max.	12 (10)	
Case Style	TO-247AC		Jedec (Modified)

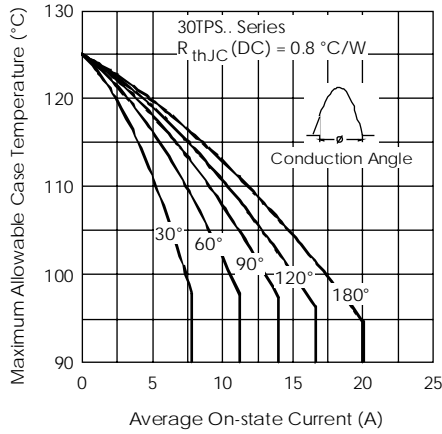

Fig. 1 - Current Rating Characteristics

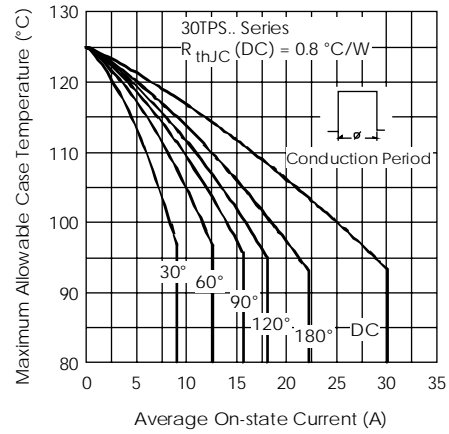

Fig. 2 - Current Rating Characteristics

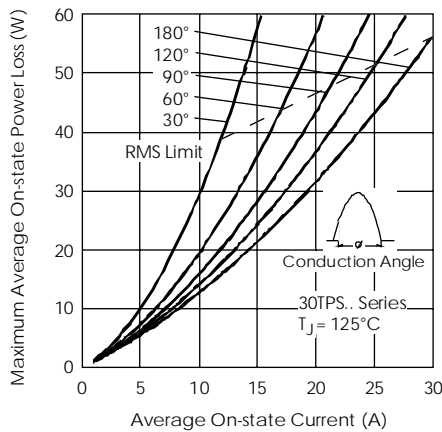

Fig. 3 - On-state Power Loss Characteristics

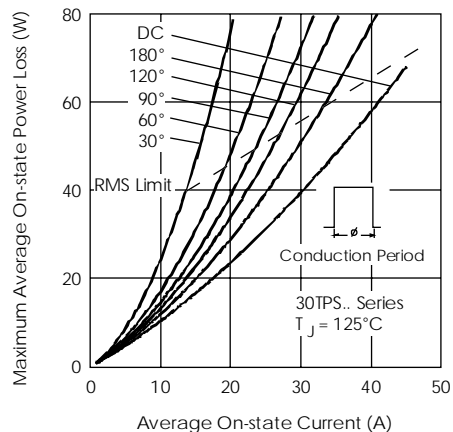

Fig. 4 - On-state Power Loss Characteristics

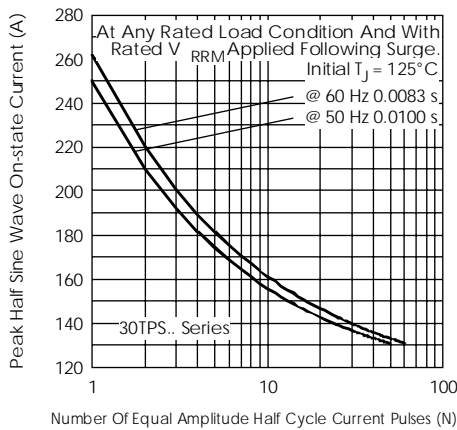

Fig. 5 - Maximum Non-Repetitive Surge Current

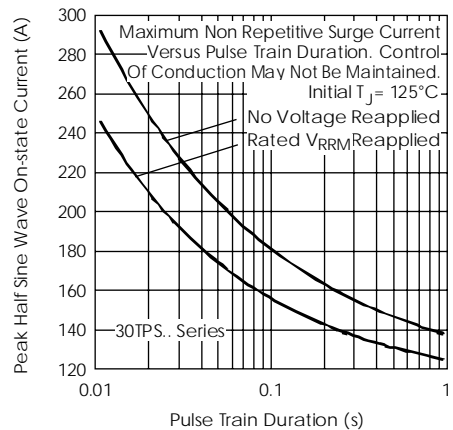

Fig. 6 - Maximum Non-Repetitive Surge Current

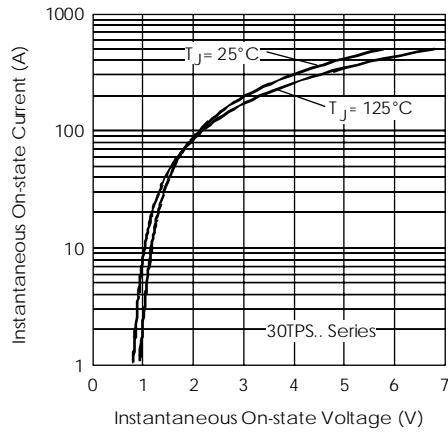

Fig. 7 - On-state Voltage Drop Characteristics

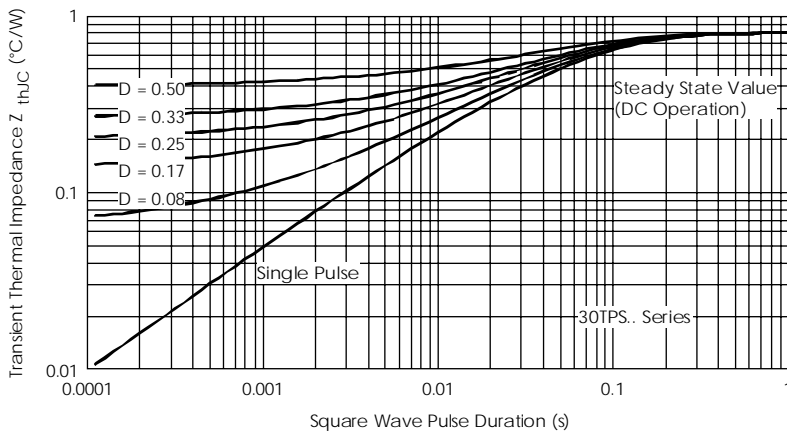

Fig. 8 - Thermal Impedance  $Z_{thJC}$  Characteristics

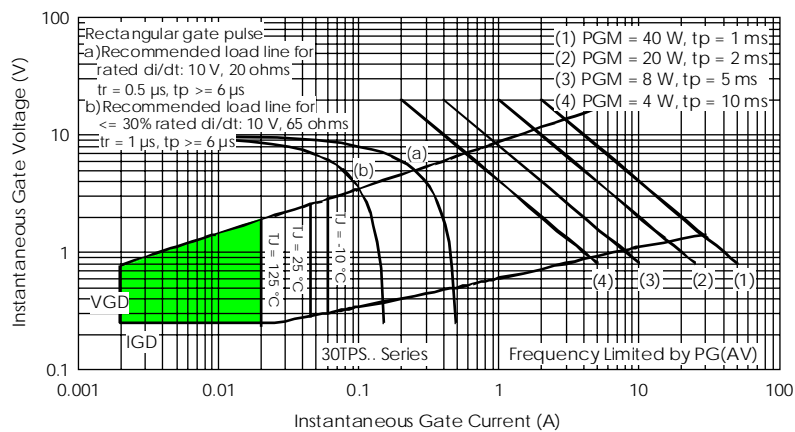
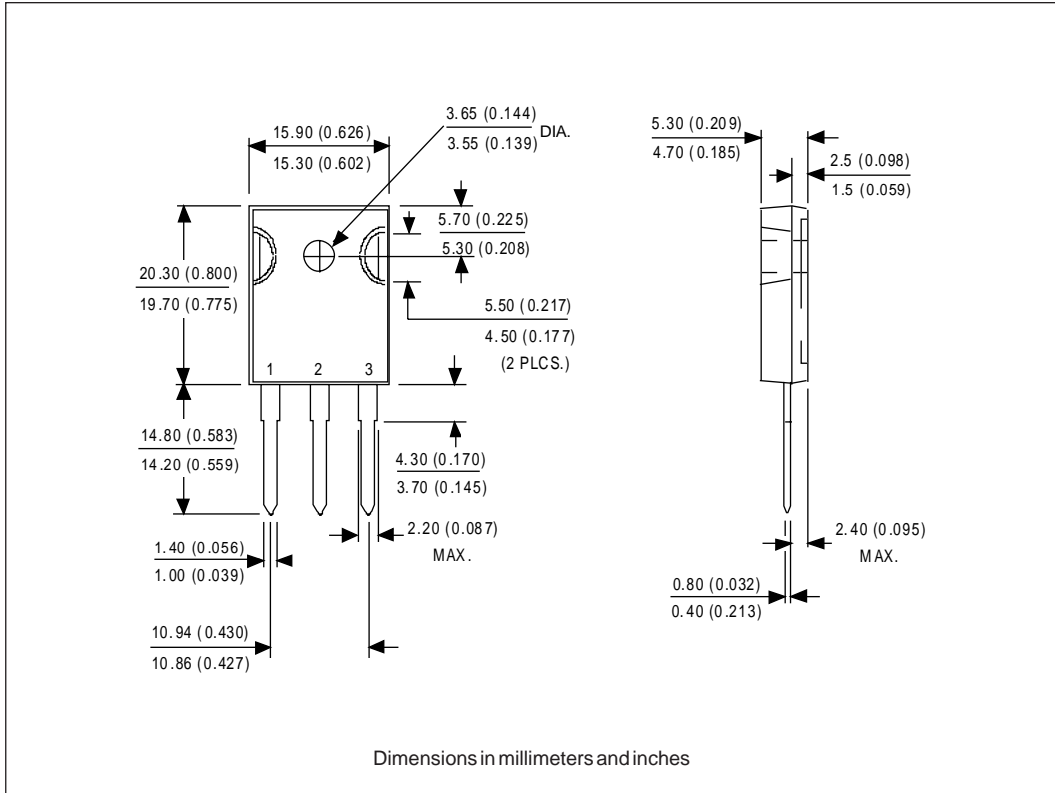

Fig. 9 - Gate Characteristics

Outline Table



Ordering Information Table

